

HEEE Series, Crimp Connection, 64 pin, Femle insert

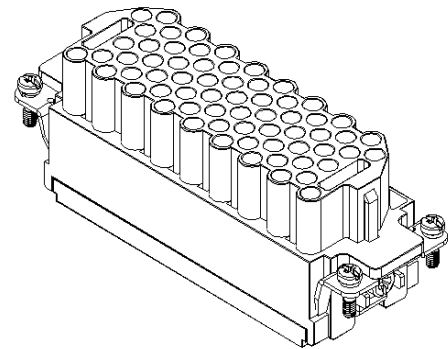
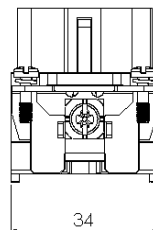
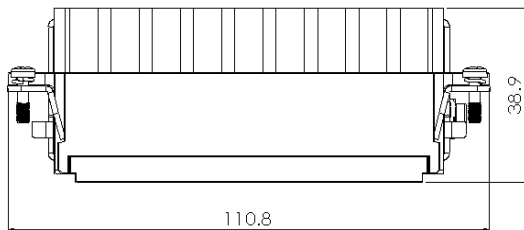

Typecode HEEE-064-FC
ID 1 007 03 0000144

Technical Data

Product Properties

Series	HEEE
Mating with	H24B
Connection mode	Crimp termination
Gender	Femle
Rated voltage	500 V
Rated current	16 A
Rated impulse voltage	6 kV
Mating contact	16 A(ESF/EGF)
Number of pins	64
Core cross-section/Clamping ability	0.14~ 4 mm ² /26 AWG ~ 12 AWG
Grounding conductor	Yes
Pollution degree	3
Insulation resistance	≥ 10 ¹⁰ Ω
Limiting temperature	-40 °C ~ +125 °C
Standard	EN 60664-1, IEC 61984

Insert

Material	PC
Colour	RAL 7032

Commercial data

Weight	0.080 kg
Packaging unit	5 pc
Country of origin	CN

Features

- High quality engineering plastics
- Crimp termination
- ≥ 500 Mating cycles
- Approval: CE
- RoHS-compliant

*这里所列的是设计数据，有关产品的变更不在此做说明，未尽事宜请联系客服。用户有责任验证功能、符合适用的法律和指令以及在特定应用中的电气安全。